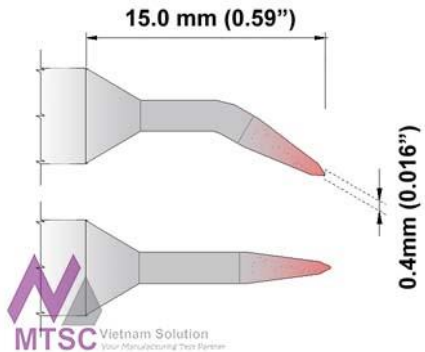

K SERIES TIP CARTRIDGES

xx = 60 (60 Series 325°C - 358°C)

xx = 75 (70 Series 350°C - 398°C)

xx = 80 (80 Series 420°C - 475°C)

 <p>15.0 mm (0.59")</p> <p>0.4 mm (0.016")</p> <p>MTSC Vietnam Solution Your Manufacturing Test Partner</p>	KxxB004	
	Bent Sharp 30° 0.4mm (0.016")	
	TMT Part#	Specification
	K60B004	See datasheet
	K75B004	See datasheet
K80B004	See datasheet	

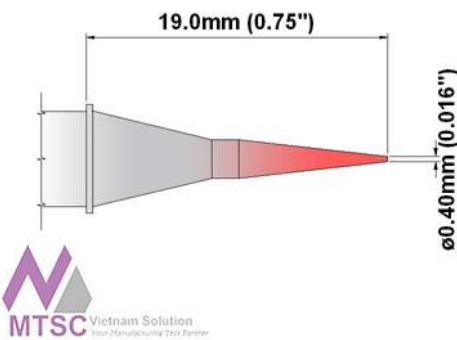
 <p>19.0 mm (0.75")</p> <p>ø0.40 mm (0.016")</p> <p>MTSC Vietnam Solution Your Manufacturing Test Partner</p>	KxxBV004	
	Conical 0.4mm (0.016")	
	TMT Part#	Specification
	K60BV004	See datasheet
	K75BV004	See datasheet
K80BV004	See datasheet	

 <p>13.00 mm (0.51")</p> <p>0.70 mm (0.028")</p> <p>Micro Fine</p> <p>MTSC Vietnam Solution Your Manufacturing Test Partner</p>	KxxBV007	
	Bevel 45° 0.7mm (0.028"), Micro Fine	
	TMT Part#	Specification
	K60BV007	See datasheet
	K75BV007	See datasheet
K80BV007	See datasheet	

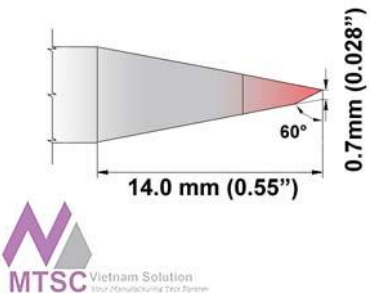
 <p>14.0 mm (0.55")</p> <p>0.7 mm (0.028")</p> <p>60°</p> <p>MTSC Vietnam Solution Your Manufacturing Test Partner</p>	Kxx BV007A	
	Bevel 60° 0.7mm (0.028")	
	TMT Part#	Specification
	K60BV007A	See datasheet
	K75BV007A	See datasheet
K80BV007A	See datasheet	

	KxxBV011	
	Bevel 60° 1.10mm (0.04")	
	TMT Part#	Specification
	K60BV011	See datasheet
	K75BV011	See datasheet
K80BV011	See datasheet	

	KxxBV020	
	Bevel 45° 2.00mm (0.08")	
	TMT Part#	Specification
	K60DT005L	See datasheet
	K75DT005L	See datasheet
K80DT005L	See datasheet	

	KxxBV030	
	Bevel 45° 3.00mm (0.12")	
	TMT Part#	Specification
	K60BV030	See datasheet
	K75BV030	See datasheet
K80BV030	See datasheet	

	KxxBV040	
	Bevel 45° 4.00mm (0.16")	
	TMT Part#	Specification
	K60BV040	See datasheet
	K75BV040	See datasheet
K80BV040	See datasheet	

	KxxBV050	
	Bevel 45° 5.00mm (0.20")	
	TMT Part#	Specification
	K60BV050	See datasheet
	K75BV050	See datasheet
K80BV050	See datasheet	

	KxxBV060	
	Bevel 45° 6.00mm (0.24")	
	TMT Part#	Specification
	K60BV060	See datasheet
	K75BV060	See datasheet
K80BV060	See datasheet	

	KxxBVF010	
	Bevel 60° 1.00mm (0.04"), Tin Area Face Only	
	TMT Part#	Specification
	K60BVF010	See datasheet
	K75BVF010	See datasheet
K80BVF010	See datasheet	

	KxxBVF020	
	Bevel 45° 2.00mm (0.08"), Tin Area Face Only	
	TMT Part#	Specification
	K60BVF020	See datasheet
	K75BVF020	See datasheet
K80BVF020	See datasheet	

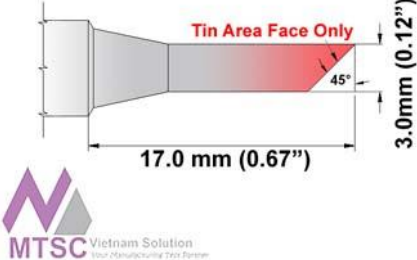
 <p>MTSC Vietnam Solution Your Manufacturing Test Partner</p>	KxxBVF030	
	Bevel 45° 3.00mm (0.12"), Tin Area Face Only	
	TMT Part#	Specification
	K60BVF030	See datasheet
	K75BVF030	See datasheet
	K80BVF030	See datasheet

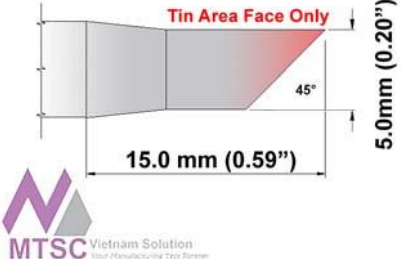
 <p>MTSC Vietnam Solution Your Manufacturing Test Partner</p>	KxxBVF050	
	Bevel 45° 5.00mm (0.20"), Tin Area Face Only	
	TMT Part#	Specification
	K60BVF050	See datasheet
	K75BVF050	See datasheet
	K80BVF050	See datasheet

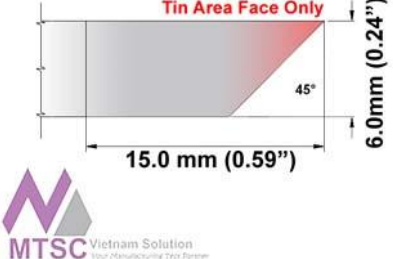
 <p>MTSC Vietnam Solution Your Manufacturing Test Partner</p>	KxxBVF060	
	Bevel 45° 6.00mm (0.24"), Tin Area Face Only	
	TMT Part#	Specification
	K60BVF060	See datasheet
	K75BVF060	See datasheet
	K80BVF060	See datasheet

 <p>MTSC Vietnam Solution Your Manufacturing Test Partner</p> <p>Micro Fine</p>	KxxC001	
	Conical 0.10mm (0.004"), Micro Fine	
	TMT Part#	Specification
	K60C001	See datasheet
	K75C001	See datasheet
	K80C001	See datasheet

	KxxC002	
	Conical 0.20mm (0.008"), Micro Fine	
	TMT Part#	Specification
	K60C002	See datasheet
	K75C002	See datasheet
K80C002	See datasheet	

	KxxC004	
	Conical 0.40mm (0.016"), Micro Fine	
	TMT Part#	Specification
	K60C004	See datasheet
	K75C004	See datasheet
K80C004	See datasheet	

	KxxCB012	
	Chisel Bent 30° 1.2mm (0.05")	
	TMT Part#	Specification
	K60CB012	See datasheet
	K75CB012	See datasheet
K80CB012	See datasheet	



	KxxCB035	
	Chisel Bent 30° 3.5mm (0.14")	
	TMT Part#	Specification
	K60CB035	See datasheet
	K75CB035	See datasheet
K80CB035	See datasheet	



	KxxCH006	
	Chisel 30° 0.6mm (0.024"), Micro Fine	
	TMT Part#	Specification
	K60CH006	See datasheet
	K75CH006	See datasheet
K80CH006	See datasheet	

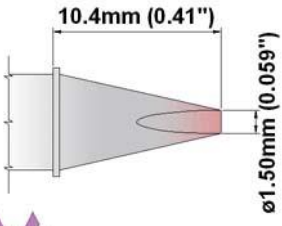

	KxxCH008	
	Chisel 30° 0.8mm (0.031"), Micro Fine	
	TMT Part#	Specification
	K60CH008	See datasheet
	K75CH008	See datasheet
K80CH008	See datasheet	

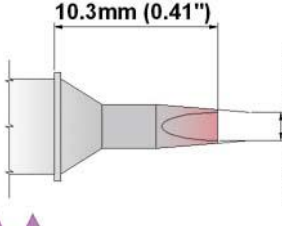

	KxxCH010	
	Chisel 30° 1.0mm (0.04")	
	TMT Part#	Specification
	K60CH010	See datasheet
	K75CH010	See datasheet
K80CH010	See datasheet	

	KxxCH010A	
	Chisel 30° 1.0mm (0.04")	
	TMT Part#	Specification
	K60CH010A	See datasheet
	K75CH010A	See datasheet
K80CH010A	See datasheet	

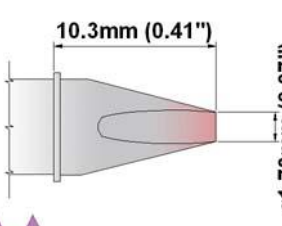
 <p>10.4mm (0.41")</p> <p>ø1.50mm (0.059")</p> 	KxxCH015	
	Chisel 30° 1.50mm (0.06")	
	TMT Part#	Specification
	K60CH015	See datasheet
	K75CH015	See datasheet
K80CH015	See datasheet	

 <p>10.3mm (0.41")</p> <p>1.78mm (0.07")</p> 	KxxCH016	
	Chisel 30° 1.78mm (0.07")	
	TMT Part#	Specification
	K60CH016	See datasheet
	K75CH016	See datasheet
K80CH016	See datasheet	

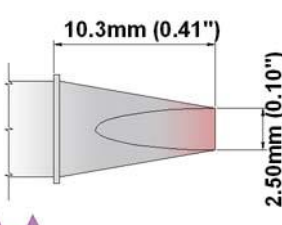
 <p>10.3mm (0.41")</p> <p>ø1.78mm (0.07")</p> 	KxxCH018	
	Chisel 30° 1.78mm (0.07")	
	TMT Part#	Specification
	K60CH018	See datasheet
	K75CH018	See datasheet
K80CH018	See datasheet	

 <p>10.3mm (0.41")</p> <p>2.50mm (0.10")</p> 	KxxCH025	
	Chisel 30° 2.5mm (0.10")	
	TMT Part#	Specification
	K60CH025	See datasheet
	K75CH025	See datasheet
K80CH025	See datasheet	

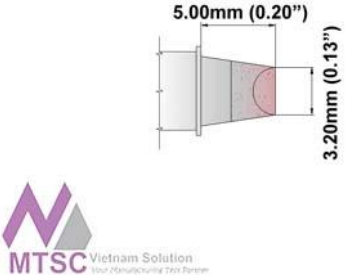
	KxxCH032	
	Chisel 90° 3.20mm (0.13")	
	TMT Part#	Specification
	K60CH032	See datasheet
	K75CH032	See datasheet
	K80CH032	See datasheet

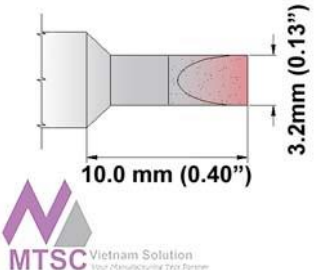
	KxxCH032A	
	Chisel 30° 3.20mm (0.13")	
	TMT Part#	Specification
	K60CH032A	See datasheet
	K75CH032A	See datasheet
	K80CH032A	See datasheet

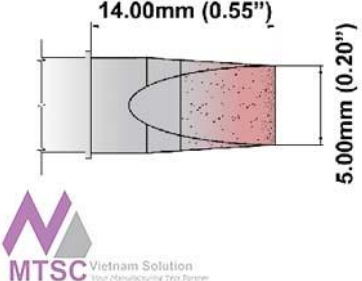
	KxxCH050	
	Chisel Extra Large 5.0mm (0.20")	
	TMT Part#	Specification
	K60CH050	See datasheet
	K75CH050	See datasheet
	K80CH050	See datasheet

	KxxCH060	
	Chisel 50%deg; 6.0mm (0.24"), Power Plus	
	TMT Part#	Specification
	K60CH060	See datasheet
	K75CH060	See datasheet
	K80CH060	See datasheet

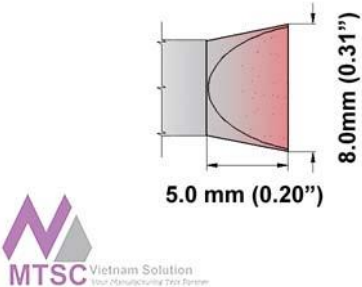
	KxxCH080	
	Chisel 90%deg; 8.0mm (0.32")	
	TMT Part#	Specification
	K60CH080	See datasheet
	K75CH080	See datasheet
K80CH080	See datasheet	

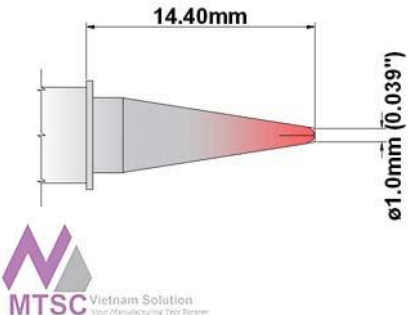
	KxxCP010	
	Conical Sharp 1.0mm (0.04")	
	TMT Part#	Specification
	K60CP010	See datasheet
	K75CP010	See datasheet
K80CP010	See datasheet	

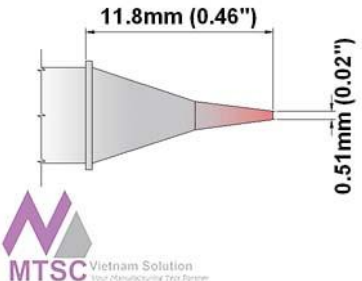
	KxxCS005	
	Conical Sharp 0.5mm (0.02")	
	TMT Part#	Specification
	K60CS005	See datasheet
	K75CS005	See datasheet
K80CS005	See datasheet	

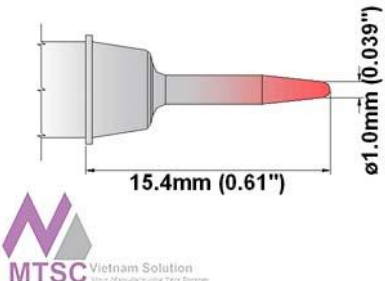
	KxxCS010	
	Conical Sharp 1.00mm (0.04")	
	TMT Part#	Specification
	K60CS010	See datasheet
	K75CS010	See datasheet
K80CS010	See datasheet	

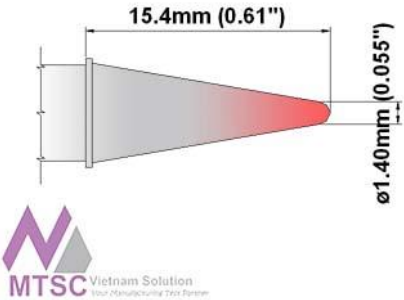
	KxxCS014	
	Conical Sharp 1.4mm (0.055")	
	TMT Part#	Specification
	K60CS014	See datasheet
	K75CS014	See datasheet
K80CS014	See datasheet	

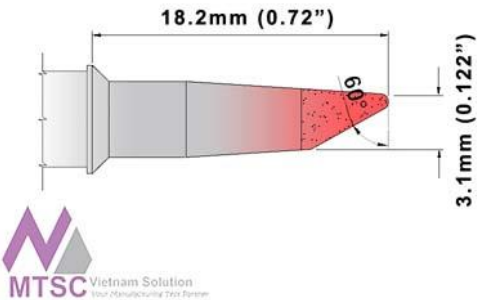
	KxxDS023	
	Hoof 60° 3.10mm (0.122")	
	TMT Part#	Specification
	K60DS023	See datasheet
	K75DS023	See datasheet
K80DS023	See datasheet	

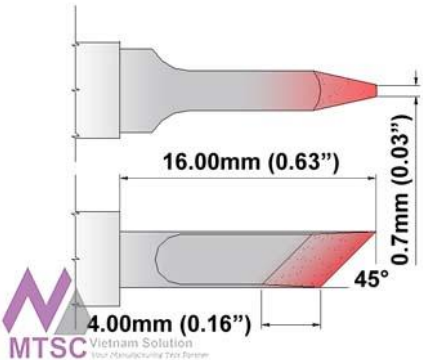
	KxxDS035	
	Knife 3.50mm (0.138")	
	TMT Part#	Specification
	K60DS035	See datasheet
	K75DS035	See datasheet
K80DS035	See datasheet	

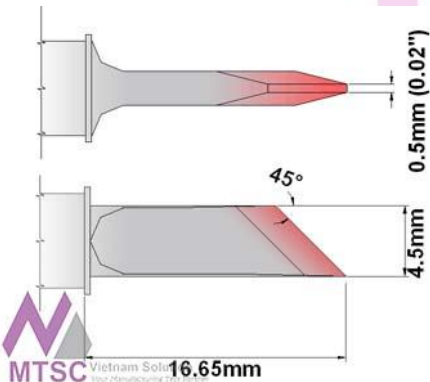
	KxxDS045	
	Knife 4.50mm (0.177")	
	TMT Part#	Specification
	K60DS045	See datasheet
	K75DS045	See datasheet
K80DS045	See datasheet	

	KxxDS061	
	Knife 4.50mm (0.177\"), Increased Tin Area 6.1mm (0.24\")	
	TMT Part#	Specification
	K60DS061	See datasheet
	K75DS061	See datasheet
K80DS061	See datasheet	

	KxxLR018	
	Chisel Long Reach 1.78mm (0.07\")	
	TMT Part#	Specification
	K60LR018	See datasheet
	K75LR018	See datasheet
K80LR018	See datasheet	

	KxxLR018A	
	Chisel Long Reach 1.78mm (0.07\")	
	TMT Part#	Specification
	K60LR018A	See datasheet
	K75LR018A	See datasheet
K80LR018A	See datasheet	

	KxxMF003	
	Micro Fine 0.25mm (0.01\")	
	TMT Part#	Specification
	K60MF003	See datasheet
	K75MF003	See datasheet
K80MF003	See datasheet	

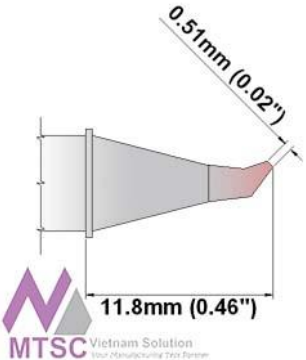
 <p>0.51mm (0.02")</p> <p>11.8mm (0.46")</p> <p>MTSC Vietnam Solution Your Manufacturing Test Partner</p>	KxxSB005	
	Bent Sharp 30° 0.51mm (0.02")	
	TMT Part#	Specification
	K60SB005	See datasheet
	K75SB005	See datasheet
K80SB005	See datasheet	

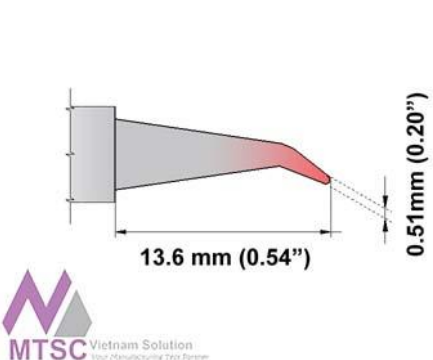
 <p>0.51mm (0.20")</p> <p>13.6 mm (0.54")</p> <p>MTSC Vietnam Solution Your Manufacturing Test Partner</p>	KxxSB005A	
	Bent Sharp 30° 0.5mm (0.02"), Power Plus	
	TMT Part#	Specification
	K60SB005A	See datasheet
	K75SB005A	See datasheet
K80SB005A	See datasheet	

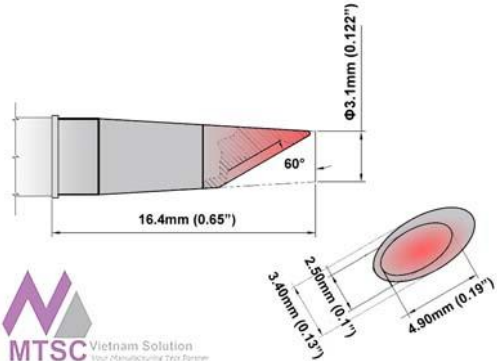
 <p>16.4mm (0.65")</p> <p>60°</p> <p>3.1mm (0.122")</p> <p>2.50mm (0.1")</p> <p>3.40mm (0.13")</p> <p>4.90mm (0.19")</p> <p>MTSC Vietnam Solution Your Manufacturing Test Partner</p>	KxxWV031	
	Hoof w/Dent 60° 3.10mm (0.122")	
	TMT Part#	Specification
	K60WV031	See datasheet
	K75WV031	See datasheet
K80WV031	See datasheet	

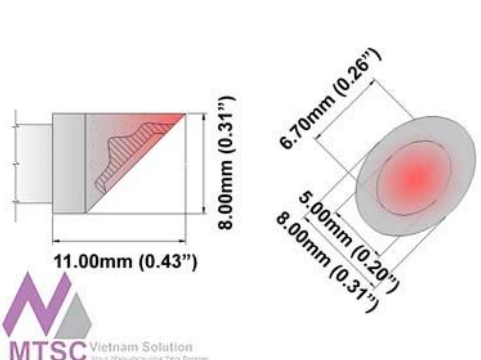
 <p>11.00mm (0.43")</p> <p>8.00mm (0.31")</p> <p>6.70mm (0.26")</p> <p>5.00mm (0.20")</p> <p>8.00mm (0.31")</p> <p>MTSC Vietnam Solution Your Manufacturing Test Partner</p>	KxxWV080	
	Hoof w/Dent 45° 8.00mm (0.12")	
	TMT Part#	Specification
	K60WV080	See datasheet
	K75WV080	See datasheet
K80WV080	See datasheet	