

M SERIES TIP CARTRIDGES

x = 6 (600 Series 325°C - 358°C)

x = 7 (700 Series 350°C - 398°C)

x = 8 (800 Series 420°C - 475°C)

	MxxB325		
	Bent Sharp 30° 0.4mm (0.016")		
	TMT Part#	Metcal® Part#	Specification
	M6B325	STTC-040	See datasheet
	M7B325	STTC-140	See datasheet
M8B325	STTC-840	See datasheet	

	MxxB325H		
	Bent Sharp 30° 0.4mm (0.016"), Power Plus		
	TMT Part#	Metcal® Part#	Specification
	M6B325H	N/A	See datasheet
	M7B325H	N/A	See datasheet
M8B325H	N/A	See datasheet	

	MxxBS375		
	Bent Sharp 0.25mm (0.01")		
	TMT Part#	Metcal® Part#	Specification
	M6BS375	N/A	See datasheet
	M7BS375	N/A	See datasheet
M8BS375	N/A	See datasheet	

	MxxBS602		
	Bevel 60° 1.8mm (0.07")		
	TMT Part#	Metcal® Part#	Specification
	M6BS602	STTC-047P	See datasheet
	M7BS602	STTC-147P	See datasheet
M8BS602	STTC-847P	See datasheet	

	MxxBV007		
	Bevel 45° 0.7mm (0.028\"), Micro Fine		
	TMT Part#	Metcal® Part#	Specification
	M6BV007	N/A	See datasheet
	M7BV007	N/A	See datasheet
M8BV007	N/A	See datasheet	

	MxxBV010		
	Bevel 60° 1.00mm (0.04\"		
	TMT Part#	Metcal® Part#	Specification
	M6BV010	N/A	See datasheet
	M7BV010	N/A	See datasheet
M8BV010	N/A	See datasheet	

	MxxBV010H		
	Bevel 60° 1.10mm (0.04\"), Power Plus		
	TMT Part#	Metcal® Part#	Specification
	M6BV010H	N/A	See datasheet
	M7BV010H	N/A	See datasheet
M8BV010H	N/A	See datasheet	

	MxxBV020H		
	Bevel 45° 2.00mm (0.08\"), Power Plus		
	TMT Part#	Metcal® Part#	Specification
	M6BV020H	N/A	See datasheet
	M7BV020H	N/A	See datasheet
M8BV020H	N/A	See datasheet	

	MxxBV030		
	Bevel 45° 3.00mm (0.12")		
	TMT Part#	Metcal® Part#	Specification
	M6BV030	N/A	See datasheet
	M7BV030	N/A	See datasheet
M8BV030	N/A	See datasheet	

	MxxBV030H		
	Bevel 45° 3.00mm (0.12"), Power Plus		
	TMT Part#	Metcal® Part#	Specification
	M6BV030H	N/A	See datasheet
	M7BV030H	N/A	See datasheet
M8BV030H	N/A	See datasheet	

	MxxBV040H		
	Bevel 45° 4.00mm (0.16"), Power Plus		
	TMT Part#	Metcal® Part#	Specification
	M6BV040H	N/A	See datasheet
	M7BV040H	N/A	See datasheet
M8BV040H	N/A	See datasheet	

	MxxBV050H		
	Bevel 45° 5.00mm (0.20"), Power Plus		
	TMT Part#	Metcal® Part#	Specification
	M6BV050H	N/A	See datasheet
	M7BV050H	N/A	See datasheet
M8BV050H	N/A	See datasheet	

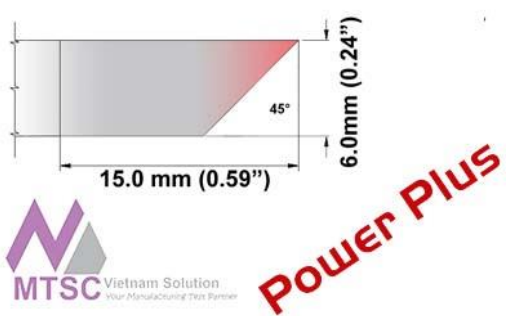
	MxxBV060H		
	Bevel 45° 6.00mm (0.24"), Power Plus		
	TMT Part#	Metcal® Part#	Specification
	M6BV060H	N/A	See datasheet
	M7BV060H	N/A	See datasheet
M8BV060H	N/A	See datasheet	

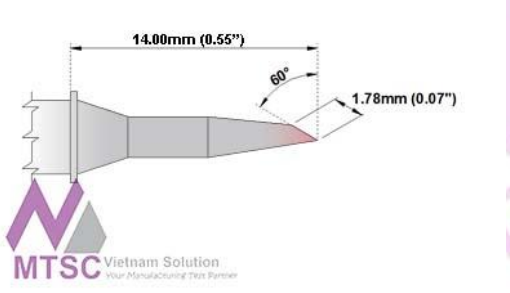
	MxxBV350		
	Bevel 60° 1.78mm (0.07")		
	TMT Part#	Metcal® Part#	Specification
	M6BV350	STTC-047	See datasheet
	M7BV350	STTC147	See datasheet
M8BV350	STTC-847	See datasheet	

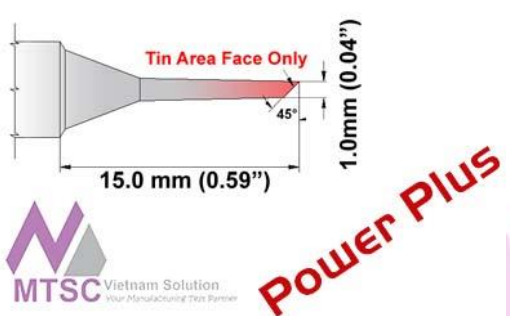
	MxxBVF010H		
	Bevel 60° 1.00mm (0.04"), Tin Area Face Only, Power Plus		
	TMT Part#	Metcal® Part#	Specification
	M6BVF010H	N/A	See datasheet
	M7BVF010H	N/A	See datasheet
M8BVF010H	N/A	See datasheet	

	MxxBVF020H		
	Bevel 45° 2.00mm (0.08"), Tin Area Face Only, Power Plus		
	TMT Part#	Metcal® Part#	Specification
	M6BVF020H	N/A	See datasheet
	M7BVF020H	N/A	See datasheet
M8BVF020H	N/A	See datasheet	

	MxxBVF030H		
	Bevel 45° 3.00mm (0.12"), Tin Area Face Only, Power Plus		
	TMT Part#	Metcal® Part#	Specification
	M6BVF030H	N/A	See datasheet
	M7BVF030H	N/A	See datasheet
M8BVF030H	N/A	See datasheet	

	MxxBVF050H		
	Bevel 45° 5.00mm (0.20"), Tin Area Face Only, Power Plus		
	TMT Part#	Metcal® Part#	Specification
	M6BVF050H	N/A	See datasheet
	M7BVF050H	N/A	See datasheet
M8BVF050H	N/A	See datasheet	

	MxxBVF060H		
	Bevel 45° 6.00mm (0.24"), Tin Area Face Only, Power Plus		
	TMT Part#	Metcal® Part#	Specification
	M6BVF060H	N/A	See datasheet
	M7BVF060H	N/A	See datasheet
M8BVF060H	N/A	See datasheet	

	MxxC001		
	Conical 0.10mm (0.004"), Micro Fine		
	TMT Part#	Metcal® Part#	Specification
	M6C001	N/A	See datasheet
	M7C001	N/A	See datasheet
M8C001	N/A	See datasheet	

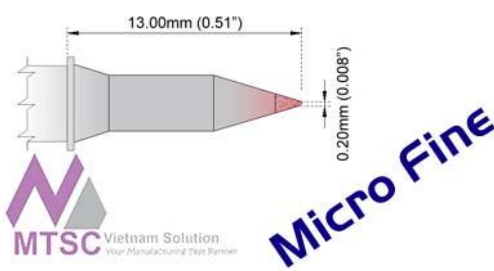
	MxxC002		
	Conical 0.20mm (0.008"), Micro Fine		
	TMT Part#	Metcal® Part#	Specification
	M6C002	N/A	See datasheet
	M7C002	N/A	See datasheet
M8C002	N/A	See datasheet	

	MxxC004		
	Conical 0.40mm (0.016"), Micro Fine		
	TMT Part#	Metcal® Part#	Specification
	M6C004	N/A	See datasheet
	M7C004	N/A	See datasheet
M8C004	N/A	See datasheet	

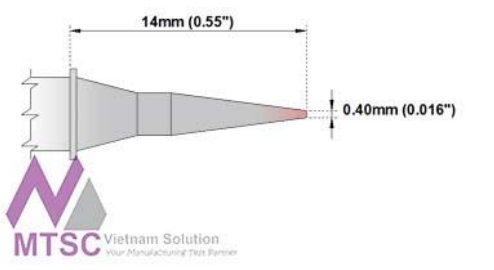
	MxxC300		
	Conical 0.4mm (0.016")		
	TMT Part#	Metcal® Part#	Specification
	M6C300	STTC-045	See datasheet
	M7C300	STTC-145	See datasheet
M8C300	STTC-845	See datasheet	

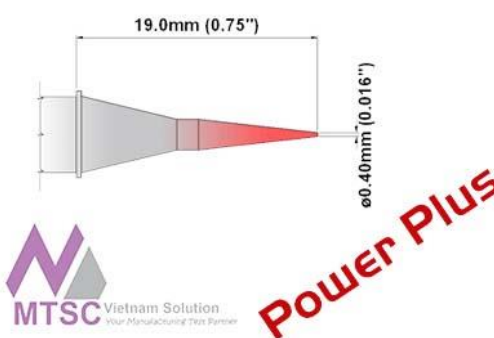
	MxxC300H		
	Conical 0.4mm (0.016"), Power Plus		
	TMT Part#	Metcal® Part#	Specification
	M6C300H	N/A	See datasheet
	M7C300H	N/A	See datasheet
M8C300H	N/A	See datasheet	

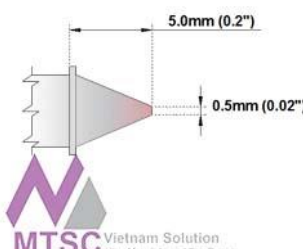
	MxxC301		
	Conical 0.5mm (0.02")		
	TMT Part#	Metcal® Part#	Specification
	M6C301	STTC-016	See datasheet
	M7C301	STTC-116	See datasheet
	M8C301	STTC-816	See datasheet

	MxxCB012H		
	Chisel Bent 30° 1.2mm (0.05"), Power Plus		
	TMT Part#	Metcal® Part#	Specification
	M6CB012H	N/A	See datasheet
	M7CB012H	N/A	See datasheet
	M8CB012H	N/A	See datasheet

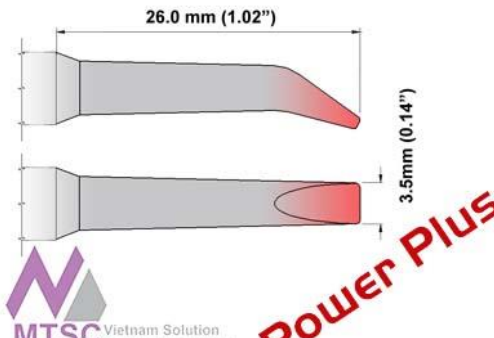
	MxxCB035H		
	Chisel Bent 30° 3.5mm (0.14"), Power Plus		
	TMT Part#	Metcal® Part#	Specification
	M6CB035H	N/A	See datasheet
	M7CB035H	N/A	See datasheet
	M8CB035H	N/A	See datasheet

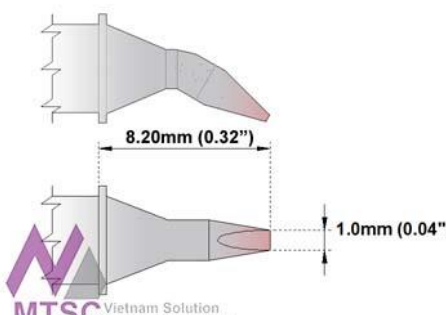
	MxxCB224		
	Chisel Bent 30° 1.0mm (0.04")		
	TMT Part#	Metcal® Part#	Specification
	M6CB224	N/A	See datasheet
	M7CB224	N/A	See datasheet
	M8CB224	N/A	See datasheet

	MxxCB225		
	Chisel Bent 30° 1.78mm (0.07")		
	TMT Part#	Metcal® Part#	Specification
	M6CB225	STTC-098	See datasheet
	M7CB225	STTC-198	See datasheet
M8CB225	STTC-898	See datasheet	

	MxxCB226		
	Chisel Bent 30° 1.5mm (0.06")		
	TMT Part#	Metcal® Part#	Specification
	M6CB226	STTC-099	See datasheet
	M7CB226	STTC-199	See datasheet
M8CB226	STTC-899	See datasheet	

	MxxCH004		
	Chisel 30° 0.4mm (0.016"), Micro Fine		
	TMT Part#	Metcal® Part#	Specification
	M6CH004	N/A	See datasheet
	M7CH004	N/A	See datasheet
M8CH004	N/A	See datasheet	

	MxxCH006		
	Chisel 30° 0.6mm (0.024"), Micro Fine		
	TMT Part#	Metcal® Part#	Specification
	M6CH006	N/A	See datasheet
	M7CH006	N/A	See datasheet
M8CH006	N/A	See datasheet	

	MxxCH008		
	Chisel 30° 0.8mm (0.031"), Micro Fine		
	TMT Part#	Metcal® Part#	Specification
	M6CH008	N/A	See datasheet
	M7CH008	N/A	See datasheet
M8CH008	N/A	See datasheet	

	MxxCH012		
	Chisel 30° 1.20mm (0.047")		
	TMT Part#	Metcal® Part#	Specification
	M6CH012	N/A	See datasheet
	M7CH012	N/A	See datasheet
M8CH012	N/A	See datasheet	

	MxxCH016		
	Chisel 30° 1.60mm (0.06")		
	TMT Part#	Metcal® Part#	Specification
	M6CH016	N/A	See datasheet
	M7CH016	N/A	See datasheet
M8CH016	N/A	See datasheet	

	MxxCH024		
	Chisel 30° 2.40mm (0.09")		
	TMT Part#	Metcal® Part#	Specification
	M6CH024	N/A	See datasheet
	M7CH024	N/A	See datasheet
M8CH024	N/A	See datasheet	

	MxxCH030		
	Chisel 30° 3.00mm (0.12")		
	TMT Part#	Metcal® Part#	Specification
	M6CH030	N/A	See datasheet
	M7CH030	N/A	See datasheet
	M8CH030	N/A	See datasheet

	MxxCH032H		
	Chisel 30° 3.20mm (0.13"), Power Plus		
	TMT Part#	Metcal® Part#	Specification
	M6CH032H	N/A	See datasheet
	M7CH032H	N/A	See datasheet
	M8CH032H	N/A	See datasheet

	MxxCH038		
	Chisel 30° 3.80mm (0.15")		
	TMT Part#	Metcal® Part#	Specification
	M6CH038	STTC-020	See datasheet
	M7CH038	STTC-120	See datasheet
	M8CH038	STTC-820	See datasheet

	MxxCH052		
	Chisel 30° 5.20mm (0.20")		
	TMT Part#	Metcal® Part#	Specification
	M6CH052	N/A	See datasheet
	M7CH052	N/A	See datasheet
	M8CH052	N/A	See datasheet

<p>MTSC Vietnam Solution Your Manufacturing Text Partner</p> <p>POWER PLUS</p>	MxxCH060H		
	Chisel 50%deg; 6.00mm (0.24\"), Power Plus		
	TMT Part#	Metcal® Part#	Specification
	M6CH060H	N/A	See datasheet
	M7CH060H	N/A	See datasheet
M8CH060H	N/A	See datasheet	

<p>MTSC Vietnam Solution Your Manufacturing Text Partner</p> <p>POWER PLUS</p>	MxxCH080H		
	Chisel 90%deg; 8.0mm (0.32\"), Power Plus		
	TMT Part#	Metcal® Part#	Specification
	M6CH080H	N/A	See datasheet
	M7CH080H	N/A	See datasheet
M8CH080H	N/A	See datasheet	

<p>MTSC Vietnam Solution Your Manufacturing Text Partner</p>	MxxCH175		
	Chisel 30° 2.5mm (0.10\"		
	TMT Part#	Metcal® Part#	Specification
	M6CH175	N/A	See datasheet
	M7CH175	N/A	See datasheet
M8CH175	N/A	See datasheet	

<p>MTSC Vietnam Solution Your Manufacturing Text Partner</p> <p>POWER PLUS</p>	MxxCH175H		
	Chisel 30° 2.5mm (0.10\"), Power Plus		
	TMT Part#	Metcal® Part#	Specification
	M6CH175H	N/A	See datasheet
	M7CH175H	N/A	See datasheet
M8CH175H	N/A	See datasheet	

	MxxCH176		
	Chisel 30° 1.78mm (0.07")		
	TMT Part#	Metcal® Part#	Specification
	M6CH176	STTC-037	See datasheet
	M7CH176	STTC-137	See datasheet
M8CH176	STTC-837	See datasheet	

	MxxCH176H		
	Chisel 30° 1.78mm (0.07"), Power Plus		
	TMT Part#	Metcal® Part#	Specification
	M6CH176H	N/A	See datasheet
	M7CH176H	N/A	See datasheet
M8CH176H	N/A	See datasheet	

	MxxCH177		
	Chisel 30° 1.5mm (0.06")		
	TMT Part#	Metcal® Part#	Specification
	M6CH177	STTC-038	See datasheet
	M7CH177	STTC-138	See datasheet
M8CH177	STTC-838	See datasheet	

	MxxCH177H		
	Chisel 30° 1.5mm (0.06"), Power Plus		
	TMT Part#	Metcal® Part#	Specification
	M6CH177H	N/A	See datasheet
	M7CH177H	N/A	See datasheet
M8CH177H	N/A	See datasheet	

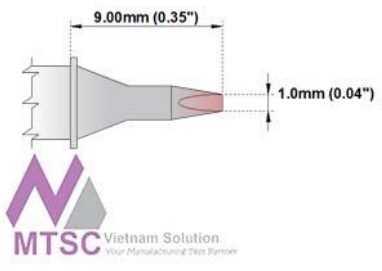
	MxxCH178		
	Chisel 30° 1.0mm (0.04")		
	TMT Part#	Metcal® Part#	Specification
	M6CH178	STTC-025	See datasheet
	M7CH178	STTC-125	See datasheet
	M8CH178	STTC-825	See datasheet

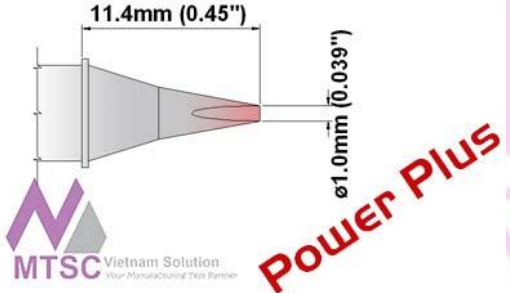
	MxxCH178H		
	Chisel 30° 1.0mm (0.04"), Power Plus		
	TMT Part#	Metcal® Part#	Specification
	M6CH178H	N/A	See datasheet
	M7CH178H	N/A	See datasheet
	M8CH178H	N/A	See datasheet

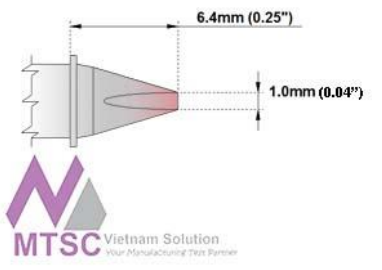
	MxxCH179		
	Chisel 30° 1.0mm (0.04")		
	TMT Part#	Metcal® Part#	Specification
	M6CH179	STTC-025P	See datasheet
	M7CH179	STTC-125P	See datasheet
	M8CH179	STTC-825P	See datasheet

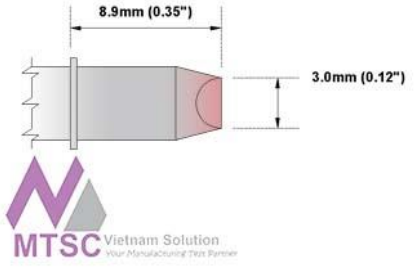
	MxxCH180		
	Chisel 90° 3.0mm (0.12")		
	TMT Part#	Metcal® Part#	Specification
	M6CH180	STTC-003	See datasheet
	M7CH180	STTC-103	See datasheet
	M8CH180	STTC-803	See datasheet

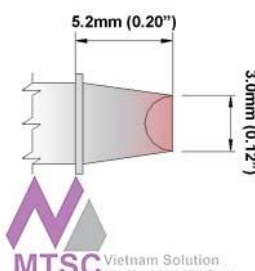
	MxxCH181		
	Chisel 90° 3.0mm (0.12")		
	TMT Part#	Metcal® Part#	Specification
	M6CH181	STTC-013	See datasheet
	M7CH181	STTC-113	See datasheet
	M8CH181	STTC-813	See datasheet

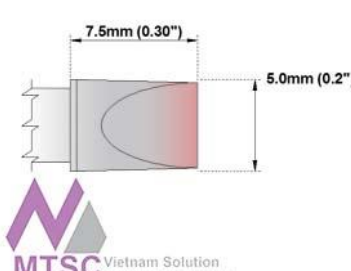
	MxxCH250		
	Chisel Extra Large 5.0mm (0.20")		
	TMT Part#	Metcal® Part#	Specification
	M6CH250	STTC-017	See datasheet
	M7CH250	STTC-117	See datasheet
	M8CH250	STTC-817	See datasheet

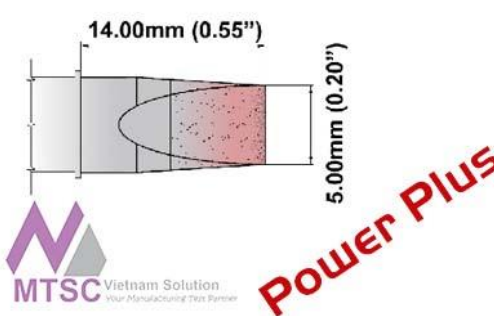
	MxxCH250H		
	Chisel Extra Large 5.0mm (0.20"), Power Plus		
	TMT Part#	Metcal® Part#	Specification
	M6CH250H	N/A	See datasheet
	M7CH250H	N/A	See datasheet
	M8CH250H	N/A	See datasheet

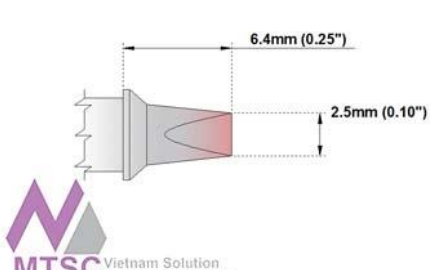
	MxxCP200		
	Chisel 30° 2.5mm (0.10")		
	TMT Part#	Metcal® Part#	Specification
	M6CP200	STTC-036P	See datasheet
	M7CP200	STTC-136P	See datasheet
	M8CP200	STTC-836P	See datasheet

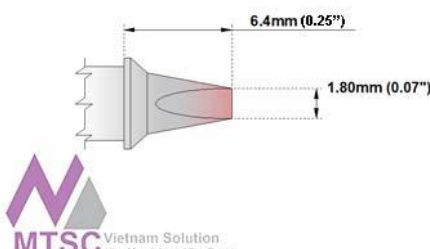
	MxxCP201		
	Chisel 30° 1.80mm (0.07")		
	TMT Part#	Metcal® Part#	Specification
	M6CP201	STTC-037P	See datasheet
	M7CP201	STTC-137P	See datasheet
M8CP201	STTC-837P	See datasheet	

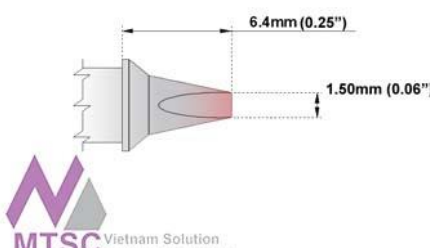
	MxxCP202		
	Chisel 30° 1.50mm (0.06")		
	TMT Part#	Metcal® Part#	Specification
	M6CP202	STTC-038P	See datasheet
	M7CP202	STTC-138P	See datasheet
M8CP202	STTC-838P	See datasheet	

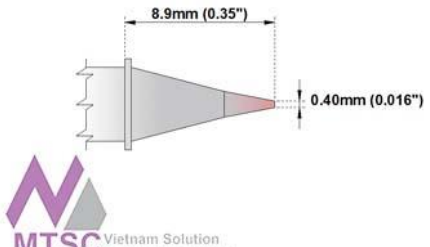
	MxxCP302		
	Conical 0.4mm (0.016")		
	TMT Part#	Metcal® Part#	Specification
	M6CP302	STTC-045P	See datasheet
	M7CP302	STTC-145P	See datasheet
M8CP302	STTC-845P	See datasheet	

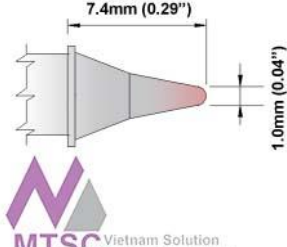
	MxxCP303		
	Conical Sharp 1.0mm (0.04")		
	TMT Part#	Metcal® Part#	Specification
	M6CP303	STTC-001P	See datasheet
	M7CP303	STTC-101P	See datasheet
M8CP303	STTC-801P	See datasheet	

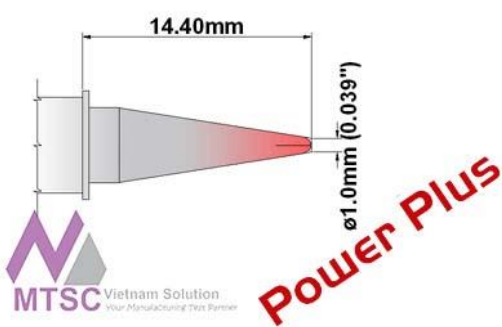
	MxxCP303H		
	Conical Sharp 1.0mm (0.04"), Power Plus		
	TMT Part#	Metcal® Part#	Specification
	M6CP303H	N/A	See datasheet
	M7CP303H	N/A	See datasheet
M8CP303H	N/A	See datasheet	

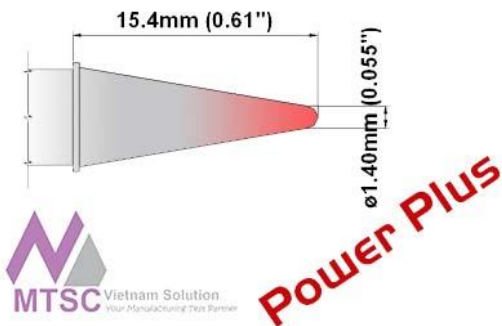
	MxxCS014H		
	Conical Sharp 1.4mm (0.055"), Power Plus		
	TMT Part#	Metcal® Part#	Specification
	M6CS014H	N/A	See datasheet
	M7CS014H	N/A	See datasheet
M8CS014H	N/A	See datasheet	

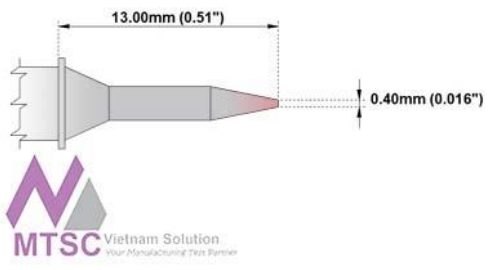
	MxxCS150		
	Conical Sharp 0.4mm (0.016")		
	TMT Part#	Metcal® Part#	Specification
	M6CS050	STTC-006	See datasheet
	M7CS050	STTC-106	See datasheet
M8CS050	STTC-806	See datasheet	

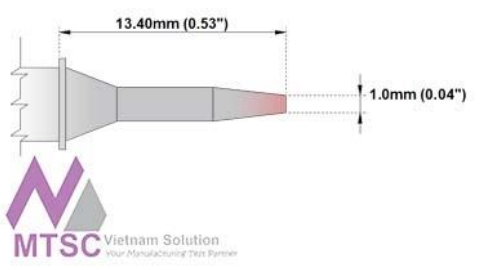
	MxxCS151		
	Conical Sharp 1.0mm (0.04")		
	TMT Part#	Metcal® Part#	Specification
	M6CS051	STTC-001	See datasheet
	M7CS051	STTC-101	See datasheet
M8CS051	STTC-801	See datasheet	

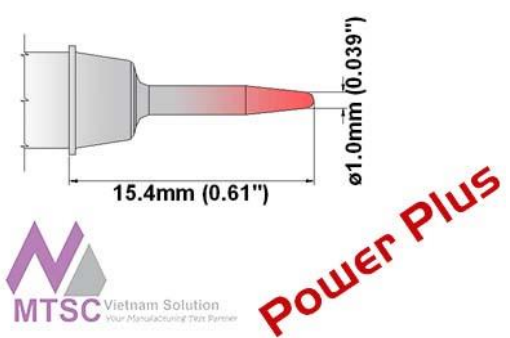
	MxxCS151H		
	Conical Sharp 1.0mm (0.04"), Power Plus		
	TMT Part#	Metcal® Part#	Specification
	M6CS051H	N/A	See datasheet
	M7CS051H	N/A	See datasheet
M8CS051H	N/A	See datasheet	

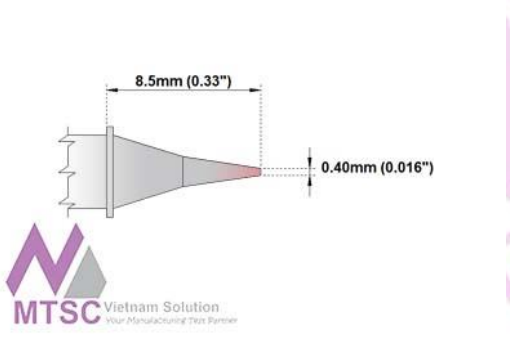
	MxxCS152		
	Conical Sharp 0.4mm (0.016")		
	TMT Part#	Metcal® Part#	Specification
	M6CS052	STTC-022	See datasheet
	M7CS052	STTC-122	See datasheet
M8CS052	STTC-822	See datasheet	

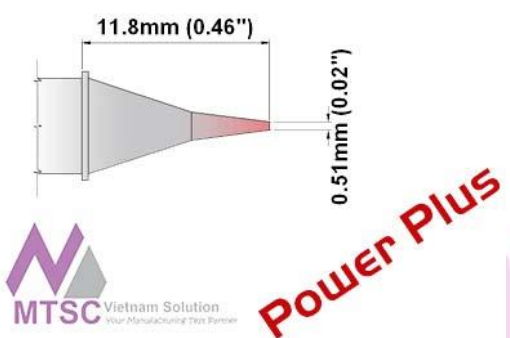
	MxxCS152H		
	Conical Sharp 0.5mm (0.02"), Power Plus		
	TMT Part#	Metcal® Part#	Specification
	M6CS052H	N/A	See datasheet
	M7CS052H	N/A	See datasheet
M8CS052H	N/A	See datasheet	

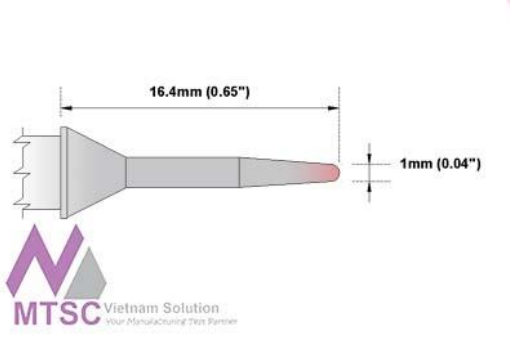
	MxxCS154		
	Conical Sharp 1.0mm (0.04")		
	TMT Part#	Metcal® Part#	Specification
	M6CS054	STTC-007	See datasheet
	M7CS054	STTC-107	See datasheet
M8CS054	STTC-807	See datasheet	

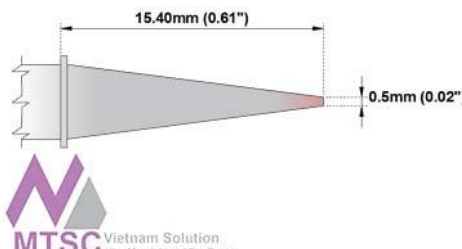
	MxxCS155		
	Conical Sharp 0.5mm (0.02")		
	TMT Part#	Metcal® Part#	Specification
	M6CS055	STTC-043	See datasheet
	M7CS055	STTC-143	See datasheet
M8CS055	STTC-843	See datasheet	

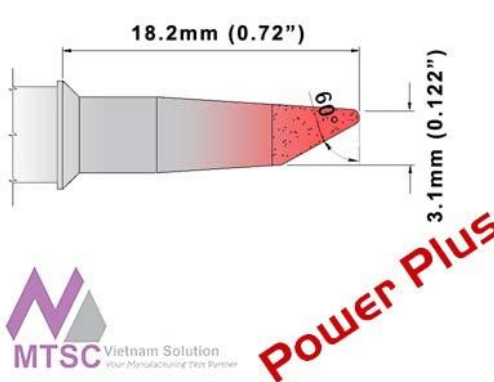
	MxxDS023H		
	Hoof 60° 3.10mm (0.122"), Power Plus		
	TMT Part#	Metcal® Part#	Specification
	M6DS023H	N/A	See datasheet
	M7DS023H	N/A	See datasheet
M8DS023H	N/A	See datasheet	

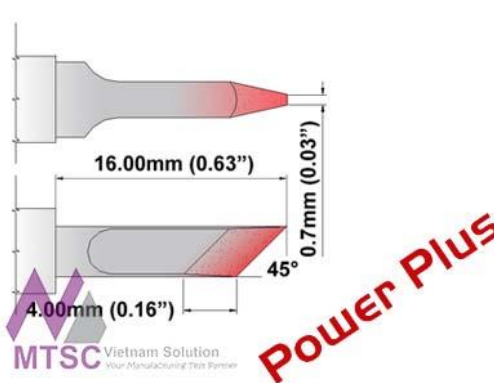
	MxxDS035H		
	Knife 3.50mm (0.138"), Power Plus		
	TMT Part#	Metcal® Part#	Specification
	M6DS035H	N/A	See datasheet
	M7DS035H	N/A	See datasheet
M8DS035H	N/A	See datasheet	

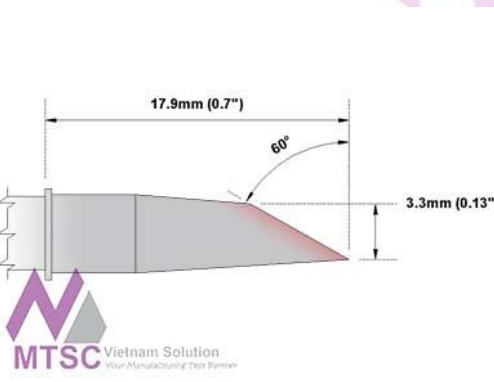
	MxxDS525		
	Hoof 60° 3.3mm (0.13")		
	TMT Part#	Metcal® Part#	Specification
	M6DS525	SMTC-0147	See datasheet
	M7DS525	SMTC-1147	See datasheet
M8DS525	SMTC-8147	See datasheet	

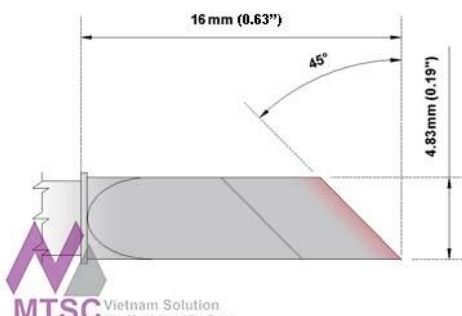
 <p>MTSC Vietnam Solution Your Manufacturing Text Partner</p>	MxxDS526		
	Knife 4.83mm (0.19"), Increased Tin Area 5.84mm (0.23")		
	TMT Part#	Metcal® Part#	Specification
	M6DS526	SMTC-0173	See datasheet
	M7DS526	SMTC-1173	See datasheet
M8DS526	SMTC-8173	See datasheet	

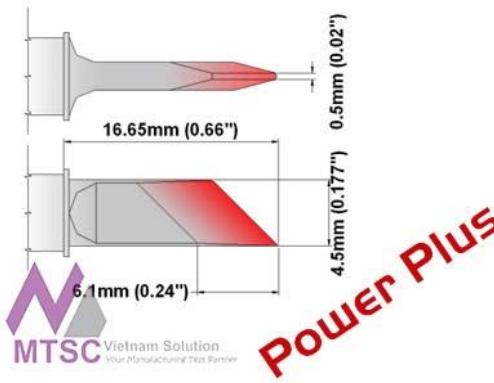
 <p>MTSC Vietnam Solution Your Manufacturing Text Partner</p> <p>POWER PLUS</p>	MxxDS526H		
	Knife 4.50mm (0.177"), Increased Tin Area 6.1mm (0.24"), Power Plus		
	TMT Part#	Metcal® Part#	Specification
	M6DS526H	N/A	See datasheet
	M7DS526H	N/A	See datasheet
M8DS526H	N/A	See datasheet	

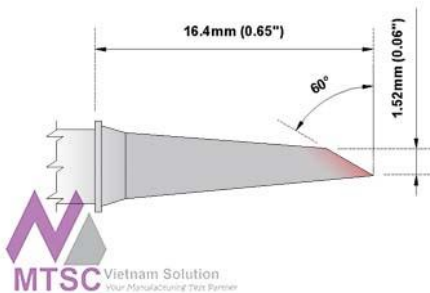
 <p>MTSC Vietnam Solution Your Manufacturing Text Partner</p>	MxxDS529		
	Hoof 60° 1.52mm (0.06")		
	TMT Part#	Metcal® Part#	Specification
	M6DS529	SMTC-0167	See datasheet
	M7DS529	SMTC-1167	See datasheet
M8DS529	SMTC-8167	See datasheet	

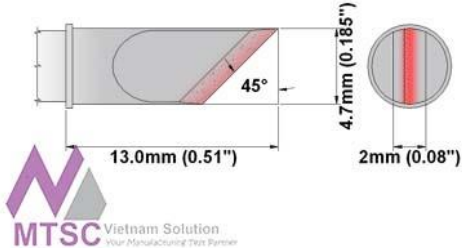
 <p>MTSC Vietnam Solution Your Manufacturing Text Partner</p>	MxxK047		
	Knife 4.70mm (0.185")		
	TMT Part#	Metcal® Part#	Specification
	M6K047	N/A	See datasheet
	M7K047	N/A	See datasheet
M8K047	N/A	See datasheet	

	MxxK100		
	Knife 4.83mm (0.19"), Tin Area 2.03mm (0.08")		
	TMT Part#	Metcal® Part#	Specification
	M6K100	SMTC-0161	See datasheet
	M7K100	SMTC-1161	See datasheet
M8K100	SMTC-8161	See datasheet	

	MxxK100H		
	Knife 4.50mm (0.177"), Power Plus		
	TMT Part#	Metcal® Part#	Specification
	M6K100H	N/A	See datasheet
	M7K100H	N/A	See datasheet
M8K100H	N/A	See datasheet	

	MxxLB124		
	Blade Tip 5.00mm (0.20")		
	TMT Part#	Metcal® Part#	Specification
	M6LB124	SMTC-064, SMTC-0BL050	See datasheet
	M7LB124	SMTC-164, SMTC-1BL050	See datasheet
M8LB124	SMTC-864, SMTC-8BL050	See datasheet	

	MxxLB125		
	Blade Tip 10.41mm (0.41")		
	TMT Part#	Metcal® Part#	Specification
	M6LB125	SMTC-060, SMTC-0BL100	See datasheet
	M7LB125	SMTC-160, SMTC-1BL100	See datasheet
M8LB125	SMTC-860, SMTC-8BL100	See datasheet	

	MxxLB126		
	Blade Tip 15.75mm (0.62")		
	TMT Part#	Metcal® Part#	Specification
	M6LB126	SMTC-061, SMTC-0BL150	See datasheet
	M7LB126	SMTC-161, SMTC-1BL150	See datasheet
M8LB126	SMTC-861, SMTC-8BL150	See datasheet	

	MxxLB127		
	Blade Tip 22.1 mm (0.87")		
	TMT Part#	Metcal® Part#	Specification
	M6LB127	SMTC-062	See datasheet
	M7LB127	SMTC-162	See datasheet
M8LB127	SMTC-862	See datasheet	

	MxxLB128		
	Blade Tip 30.0 mm (1.18")		
	TMT Part#	Metcal® Part#	Specification
	M6LB128	N/A	See datasheet
	M7LB128	N/A	See datasheet
M8LB128	N/A	See datasheet	

	MxxLC650		
	Chisel Extra Large 5.0mm (0.20")		
	TMT Part#	Metcal® Part#	Specification
	M6LC650	STTC-065	See datasheet
	M7LC650	STTC-165	See datasheet
M8LC650	STTC-865	See datasheet	

	MxxLR400		
	Bevel 60° Long Reach 1.0mm (0.04")		
	TMT Part#	Metcal® Part#	Specification
	M6LR400	STTC-046	See datasheet
	M7LR400	STTC-146	See datasheet
M8LR400	STTC-846	See datasheet	

	MxxLR401		
	Hoof Long Reach 60° 3.05mm (0.12")		
	TMT Part#	Metcal® Part#	Specification
	M6LR401	SMTC-0170	See datasheet
	M7LR401	SMTC-1170	See datasheet
M8LR401	SMTC-8170	See datasheet	

	MxxLR403		
	Chisel 60° Long Reach 1.78mm (0.07")		
	TMT Part#	Metcal® Part#	Specification
	M6LR403	STTC-042	See datasheet
	M7LR403	STTC-142	See datasheet
M8LR403	STTC-842	See datasheet	

	MxxMD575		
	Hook Long 30° Fine 0.51mm (0.02")		
	TMT Part#	Metcal® Part#	Specification
	M6MD575	SMTC-0172	See datasheet
	M7MD575	SMTC-1172	See datasheet
M8MD575	SMTC-8172	See datasheet	

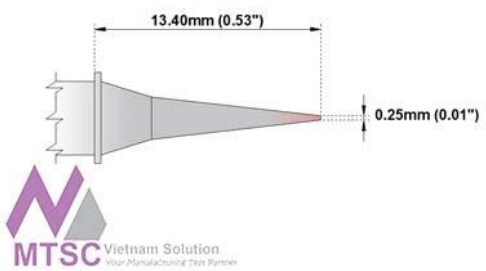
	MxxMF375		
	Micro Fine 0.25mm (0.01")		
	TMT Part#	Metcal® Part#	Specification
	M6MF375	STTC-090	See datasheet
	M7MF375	STTC-190	See datasheet
	M8MF375	STTC-890	See datasheet

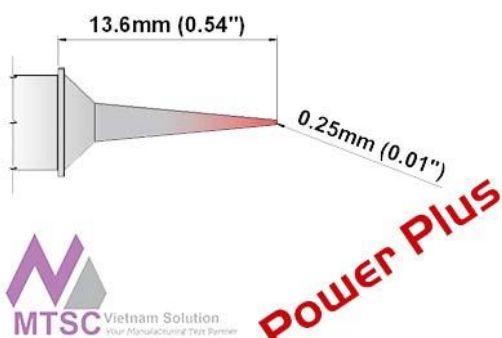
	MxxMF375H		
	Micro Fine 0.25mm (0.01"), Power Plus		
	TMT Part#	Metcal® Part#	Specification
	M6MF375H	N/A	See datasheet
	M7MF375H	N/A	See datasheet
	M8MF375H	N/A	See datasheet

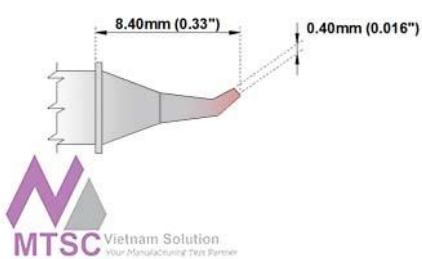
	MxxSB275		
	Bent Sharp 30° 0.4mm (0.016")		
	TMT Part#	Metcal® Part#	Specification
	M6SB275	STTC-026	See datasheet
	M7SB275	STTC-126	See datasheet
	M8SB275	STTC-826	See datasheet



	MxxSB275H		
	Bent Sharp 30° 0.5mm (0.02"), Power Plus		
	TMT Part#	Metcal® Part#	Specification
	M6SB275H	N/A	See datasheet
	M7SB275H	N/A	See datasheet
	M8SB275H	N/A	See datasheet

	MxxSB276		
	Bent Sharp 30° 0.5mm (0.02")		
	TMT Part#	Metcal® Part#	Specification
	M6SB276	STTC-044	See datasheet
	M7SB276	STTC-144	See datasheet
M8SB276	STTC-844	See datasheet	

	MxxSB276H		
	Bent Sharp 30° 0.5mm (0.02"), Power Plus		
	TMT Part#	Metcal® Part#	Specification
	M6SB276H	N/A	See datasheet
	M7SB276H	N/A	See datasheet
M8SB276H	N/A	See datasheet	

	MxxWV020		
	Hoof w/Dent 45° 2.00mm (0.08")		
	TMT Part#	Metcal® Part#	Specification
	M6WV020	N/A	See datasheet
	M7WV020	N/A	See datasheet
M8WV020	N/A	See datasheet	

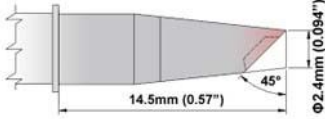
	MxxWV031		
	Hoof w/Dent 60° 3.10mm (0.122")		
	TMT Part#	Metcal® Part#	Specification
	M6WV301	N/A	See datasheet
	M7WV301	N/A	See datasheet
M8WV301	N/A	See datasheet	

 	MxxWV300		
	Hoof w/Dent 45° 2.40mm (0.09")		
	TMT Part#	Metcal® Part#	Specification
	M6WV300	N/A	See datasheet
	M7WV300	N/A	See datasheet
M8WV300	N/A	See datasheet	

